



HINWEIS

Unsere Trenneinsätze bestehen aus Kunststoff. Achte bei der Montage bitte darauf, dass die Unterlagen immer frei von Schmutz oder Spänen sind. Die Oberfläche Deines Trenneinsatzes kann schnell verkratzen.

NOTE

Our separator inserts are made of plastic. During assembly, please make sure that the supports are always free of dirt or chips. The surface of your separator insert can quickly become scratched.

Bauanleitung

Assembly Instructions

KILDWICK FREELOO

Follow us on:





Ein dickes Danke,
dass du mitmachst und dich für ökologisch-nachhaltige Toilettenlösungen von
Kildwick entschieden hast.

Willkommen in der
Kildwick Community !

Thank you very much
for participating and your decision to purchase this ecologically sustainable
Kildwick toilet solutions

Welcome to the
Kildwick Community !

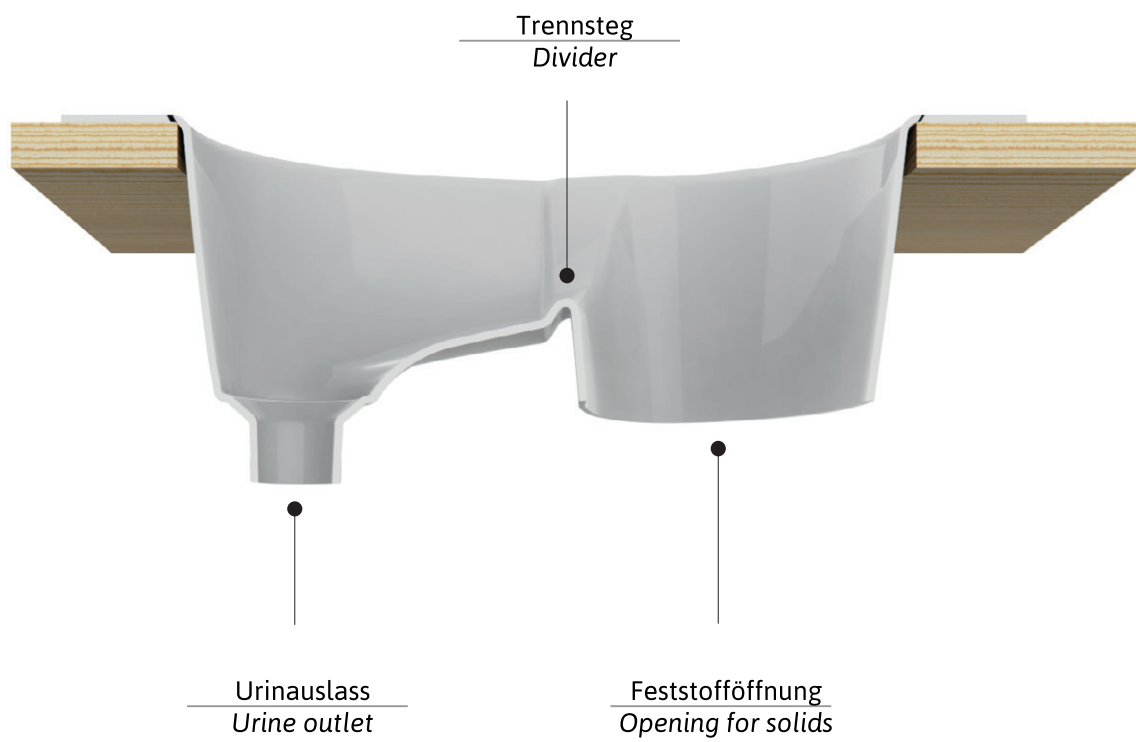



FreeLoo S Kompakt

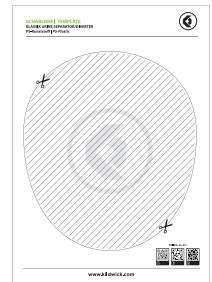
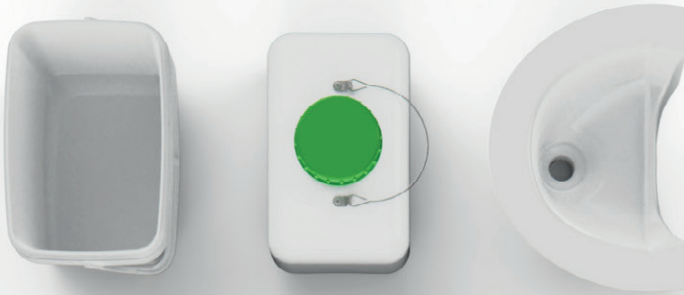

FreeLoo S Klassik

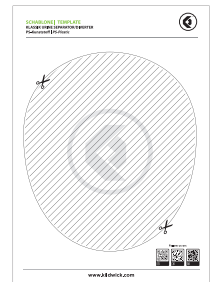
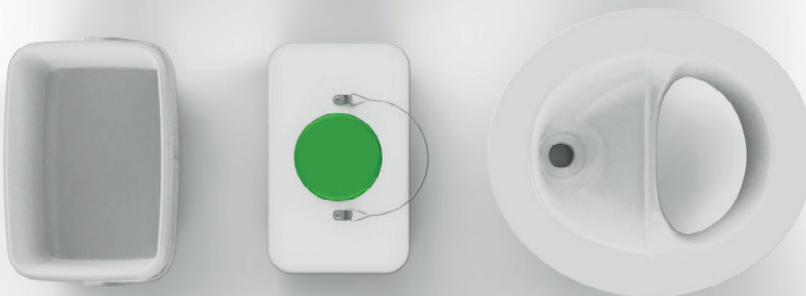

FreeLoo S Klassik XL

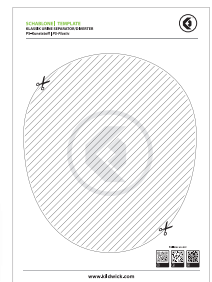



FreeLoo M Kompakt

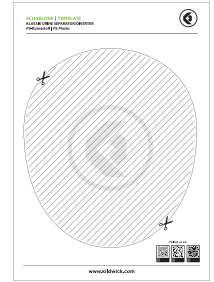

FreeLoo M Klassik

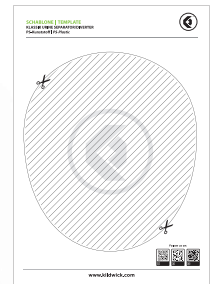
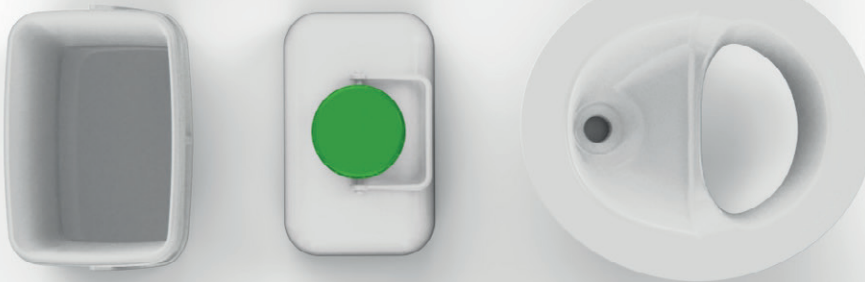

FreeLoo M Klassik XL

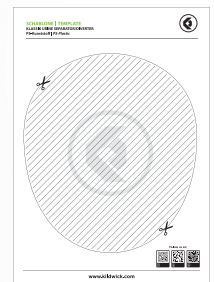



FreeLoo L Kompakt

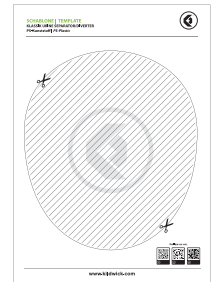

FreeLoo L Klassik

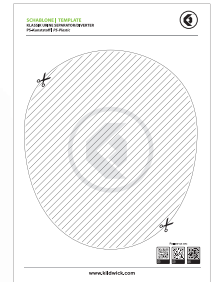
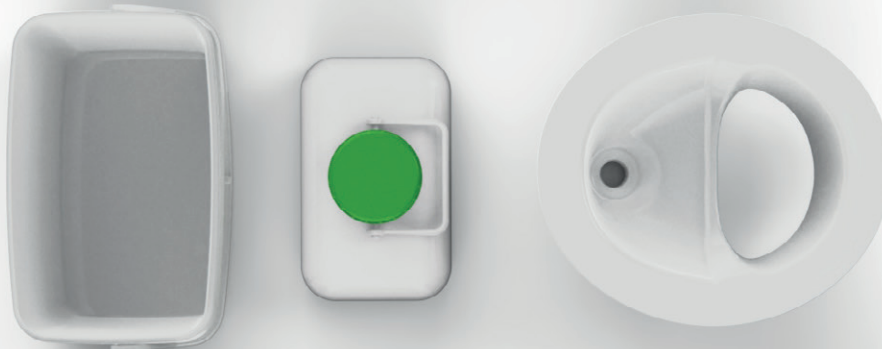

FreeLoo L Klassik XL

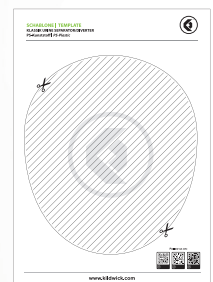
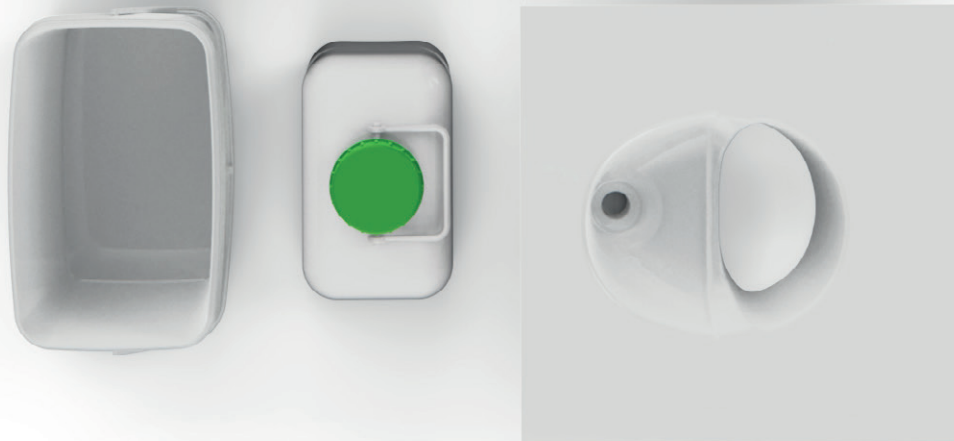



FreeLoo L

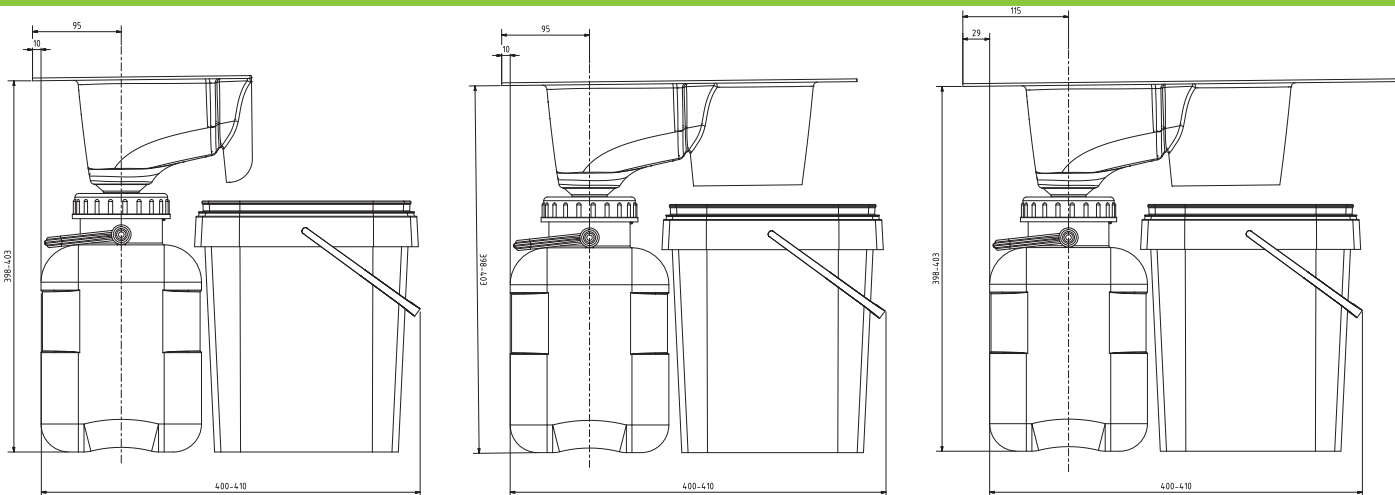

FreeLoo M

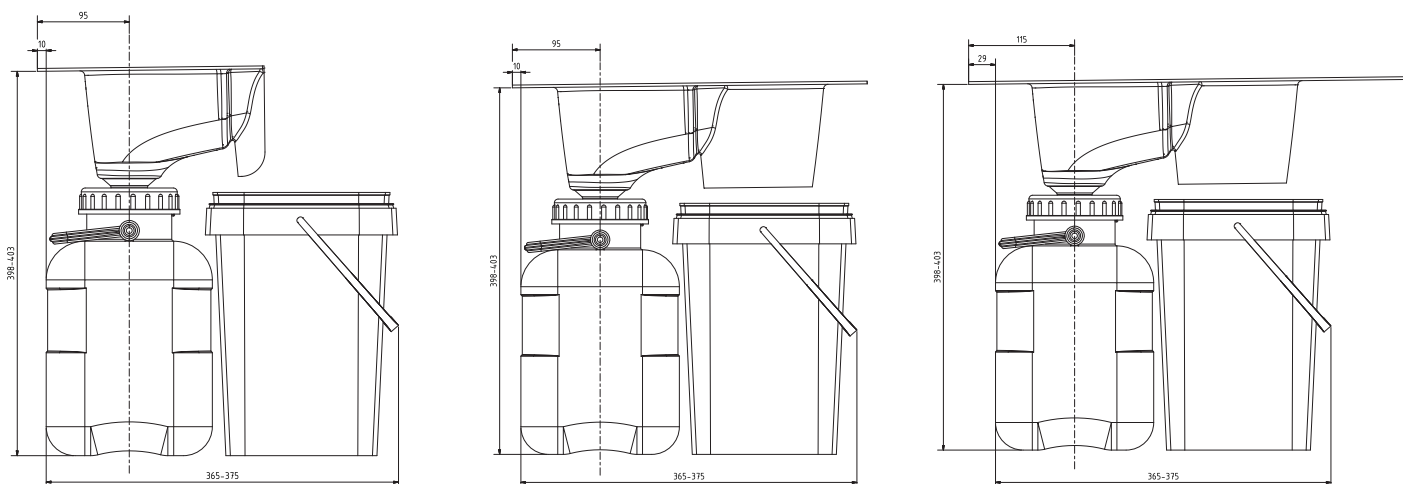

FreeLoo S

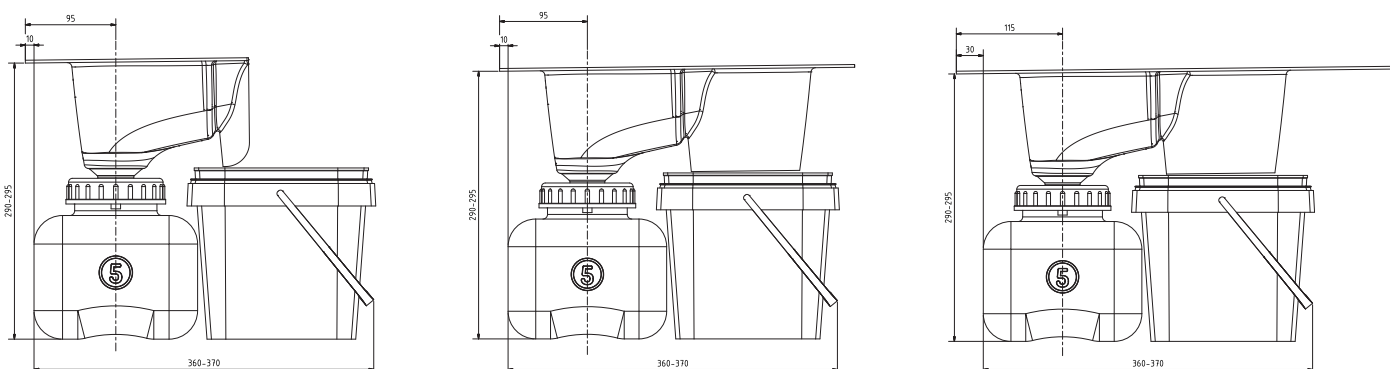



Lege die Holzplatte, in die Du später Deinen Trenneinsatz einbauen möchtest, auf Deinen Tisch.

Place the wooden plate, in which you want to install your separating insert, on your table on your table.

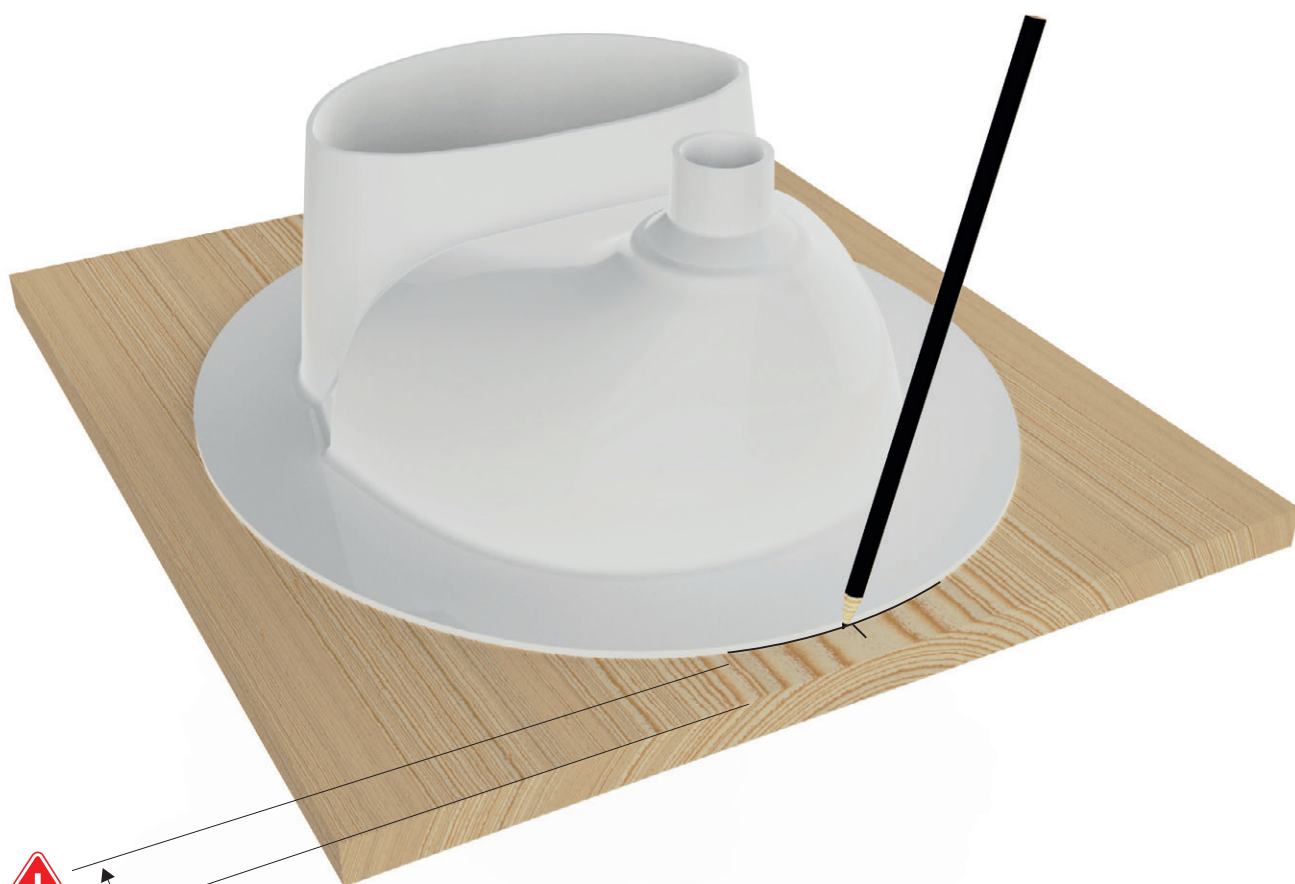

 **ABSTAND SELBST FESTLEGEN UND MARKIEREN. SIEHE TABELLE SEITE 05!**
Set and mark distance yourself. See table page 05!

Der Abstand ist abhängig von der Art des gekauften Trenneinsatzes und von der Materialstärke der Frontplatte deiner Toilette.

The distance depends on the type of separator you purchased and on the material thickness of the front panel of your toilet.

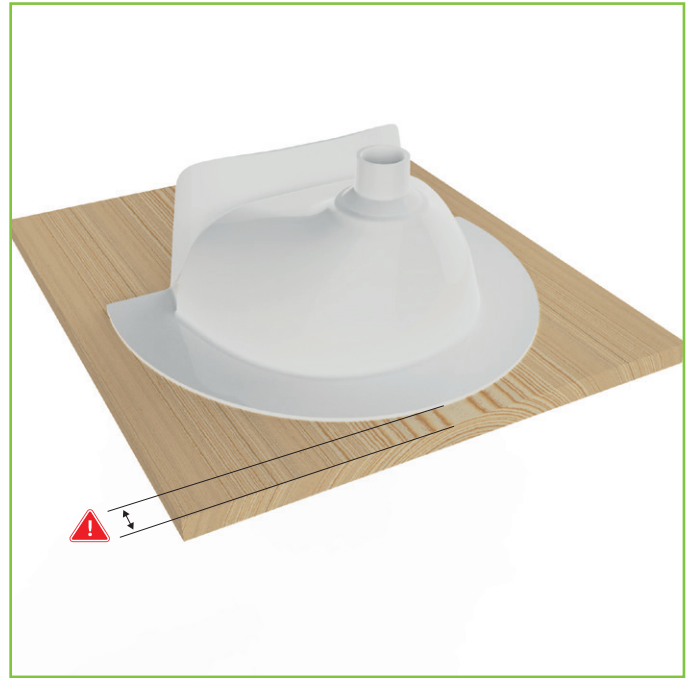
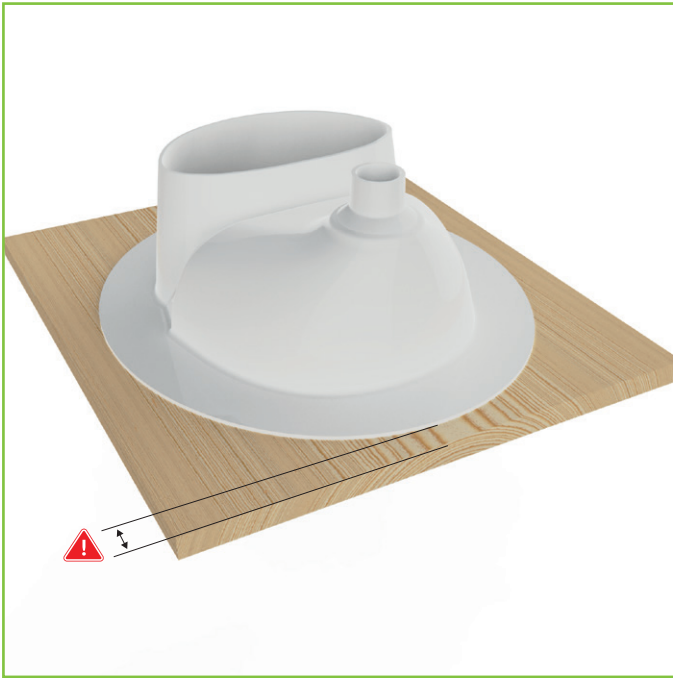

 **KILDWICK KLASSIK UND KOMPAKT IDENTISCH ANLEGEN!**
Create Kildwick Classic and Compact identically!

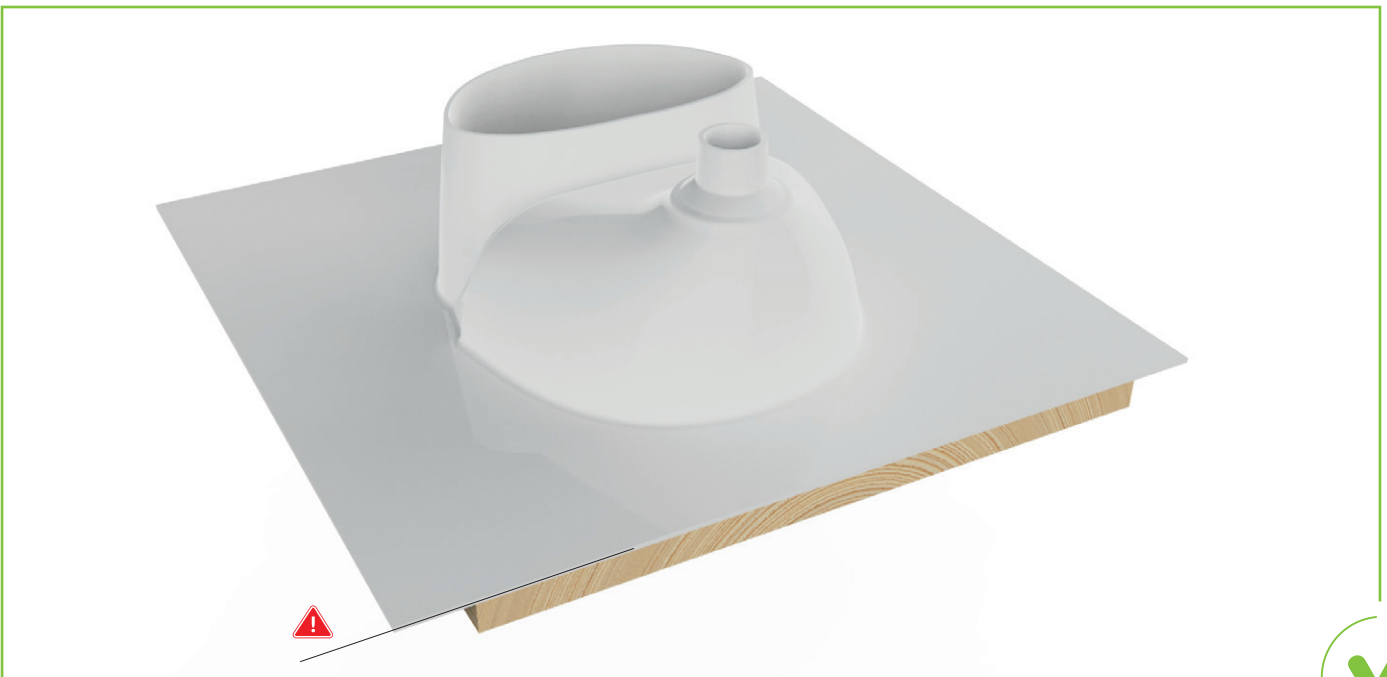

 **KILDWICK KLASSIK XL IMMER AN VORDERKANTE ANLEGEN!**
Kildwick Classic XL always apply to leading edge!



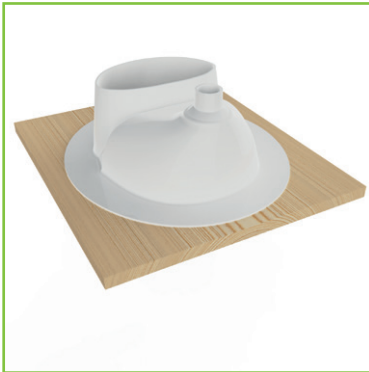

KILDWICK KLASSIK

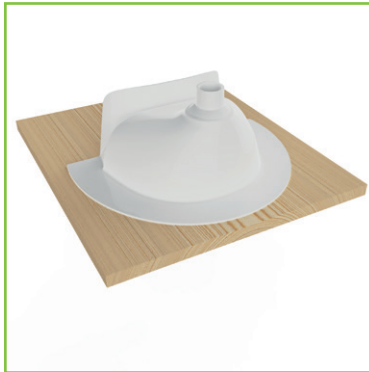

KILDWICK KOMPAKT

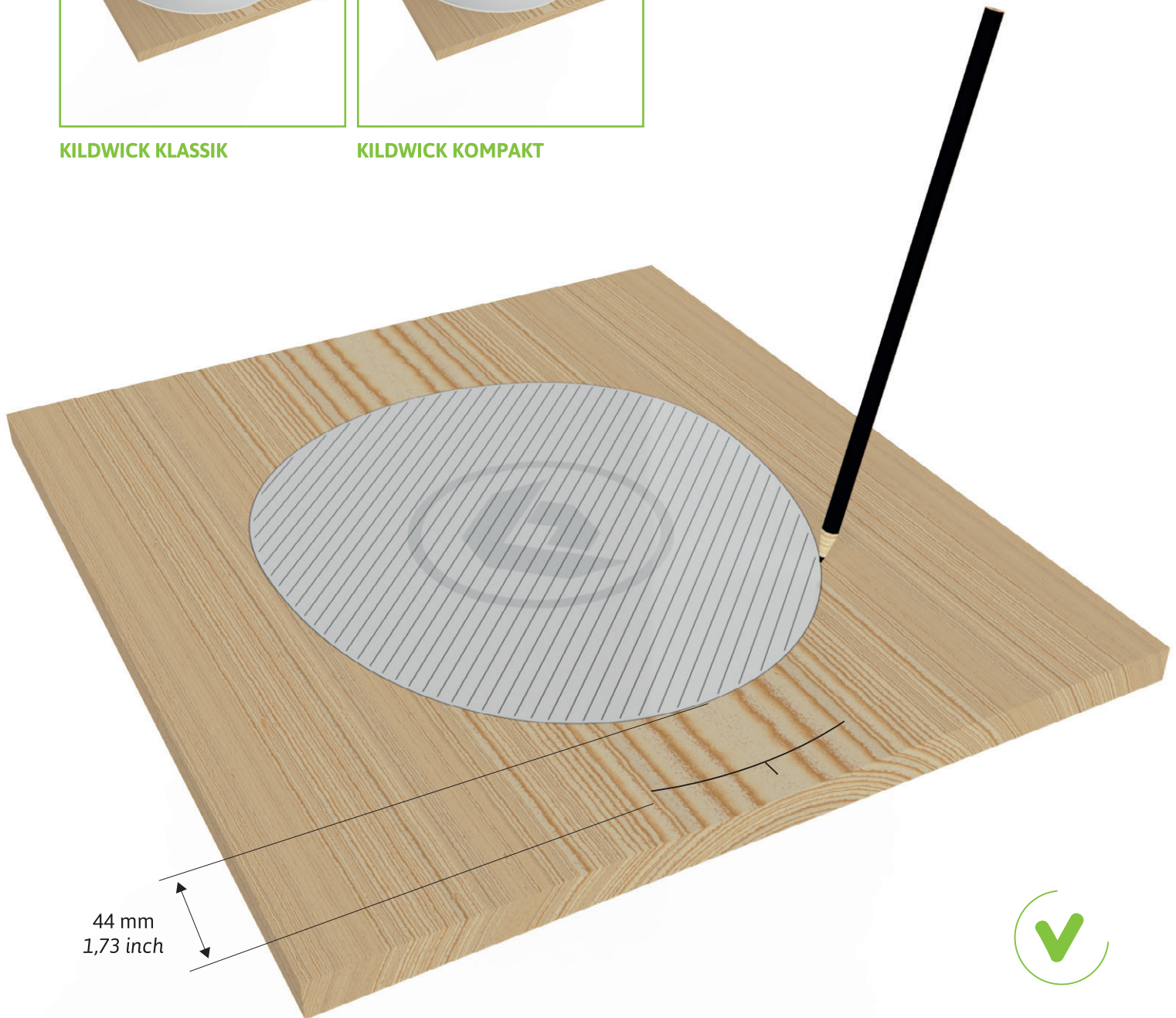

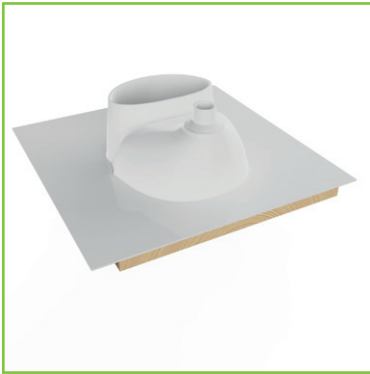

KILDWICK KLASSIK XL

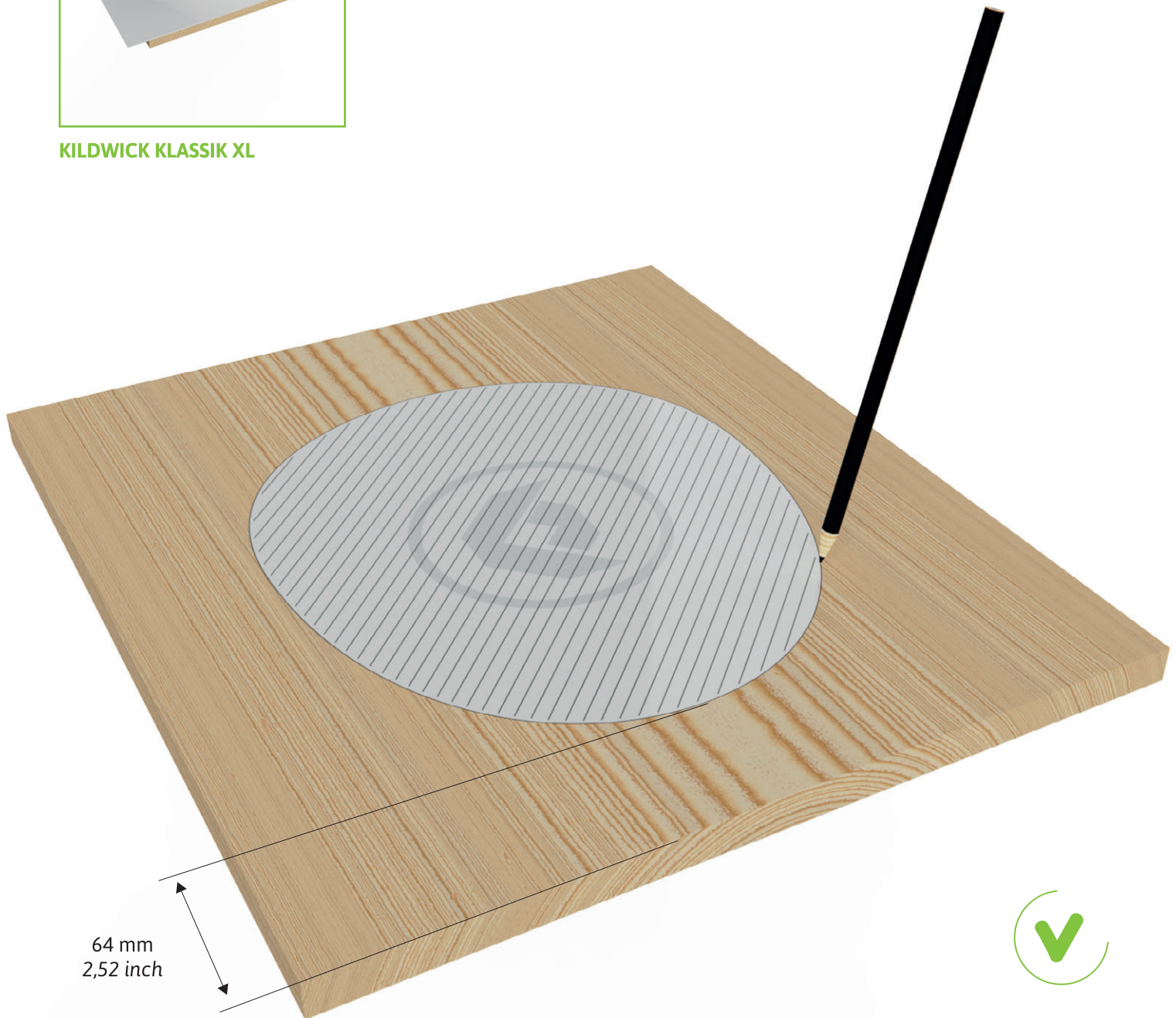

 **BEARBEITUNG TRENNEINSATZ SEITE 14-15.**
Machining separator page 14-15.

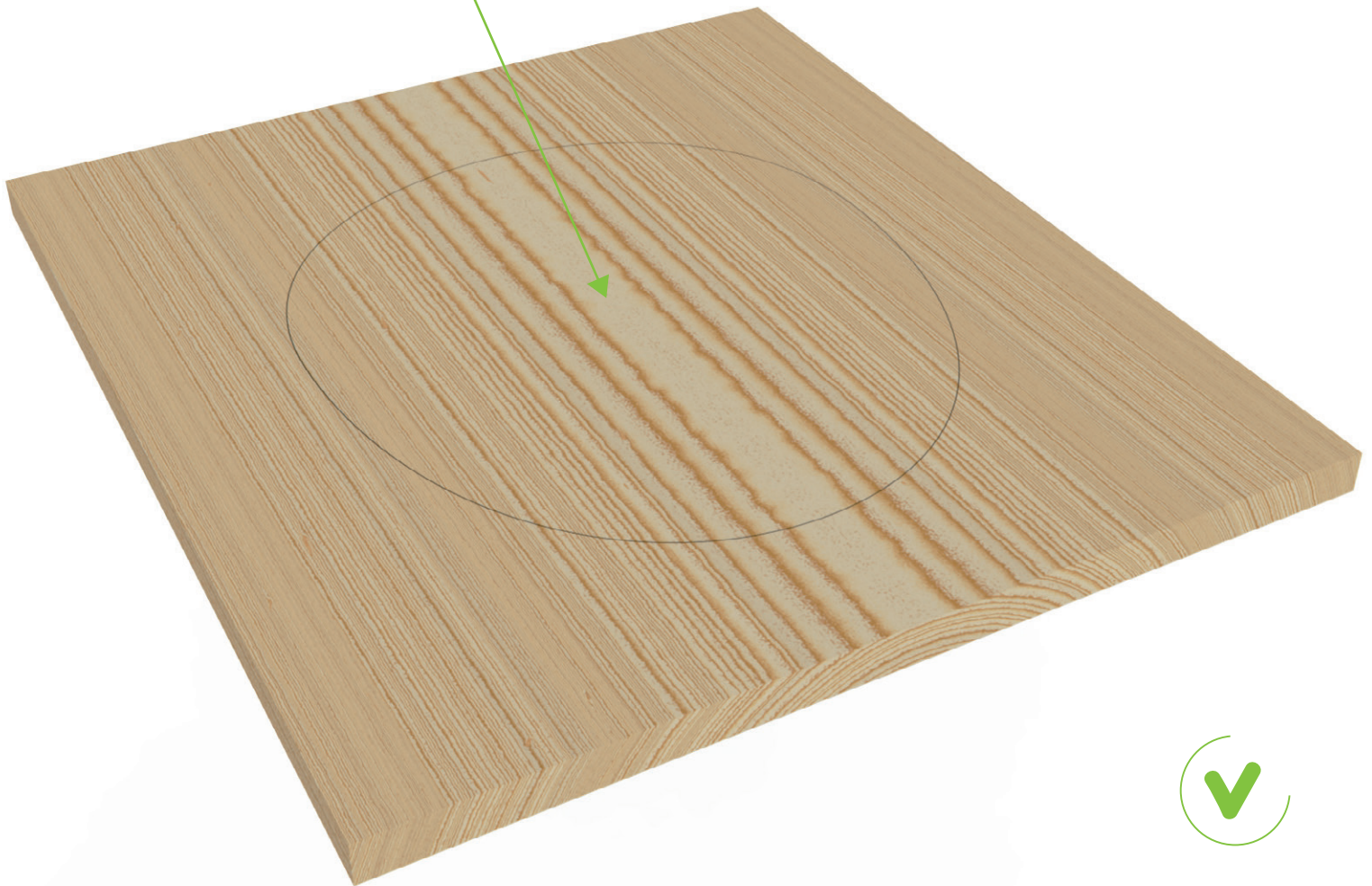
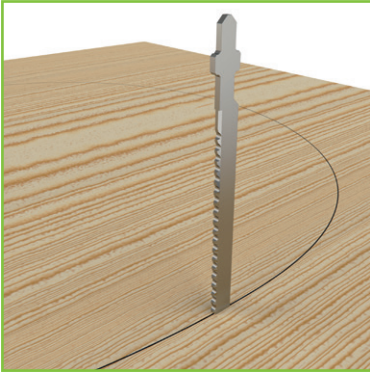

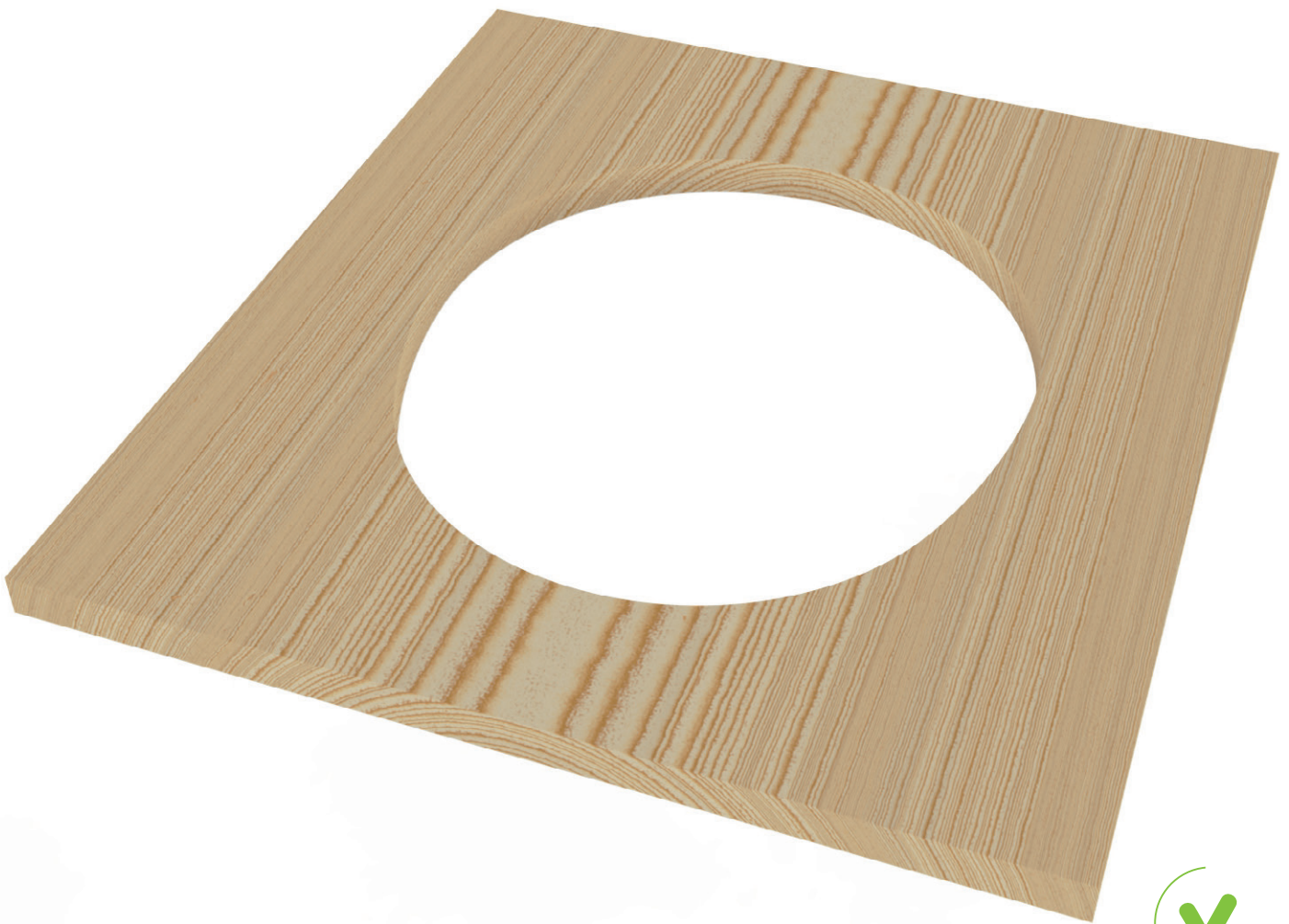

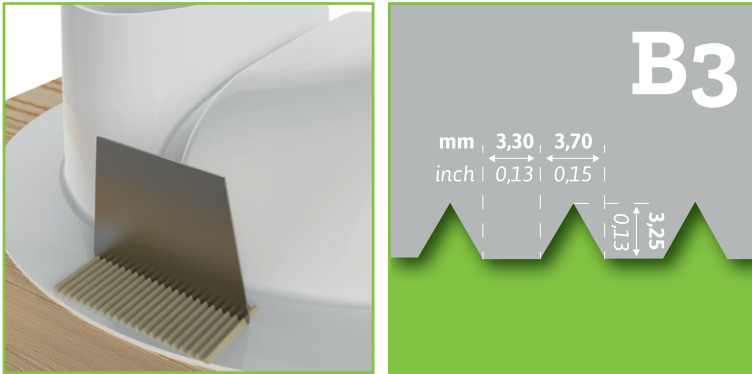

 **FLÄCHE UMLAUFEND MIT VINYLKLEBER EINSTREICHEN. SIEHE FOLGESEITE!**
Coat the surface all around with vinyl adhesive. See next page!

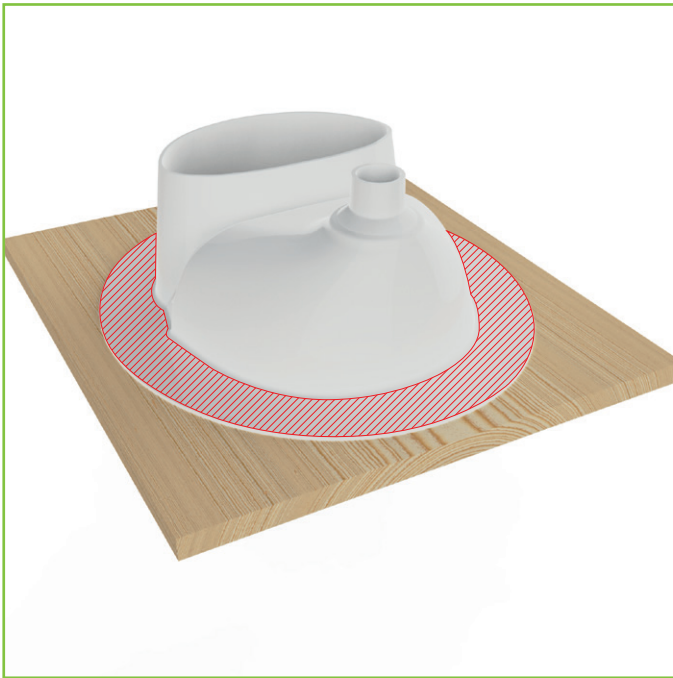

KILDWICK KLASSIK

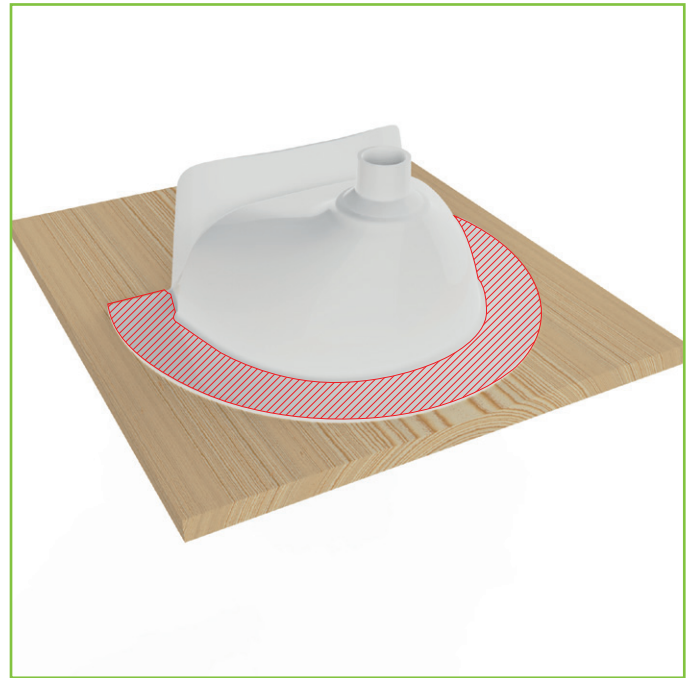

KILDWICK KOMPAKT

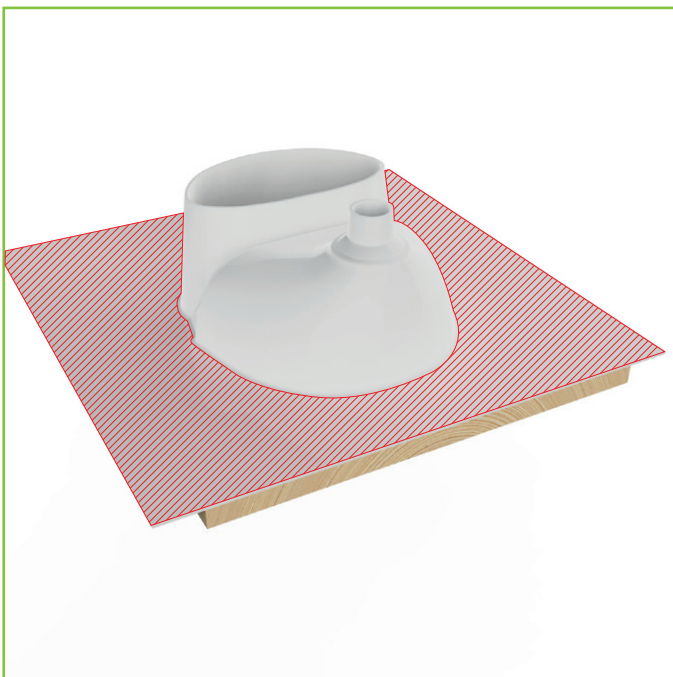

KILDWICK KLASSIK XL

Wir empfehlen Kleber für Vinylböden, der mit einem Zahnpachtel aufgetragen werden sollte. Nach dem Klebevorgang sollte der Trenneinsatz unter Druck ca. 24h trocknen.

We recommend glue for vinyl floors, which can be applied with a notched trowel. After the gluing process, the separator should dry under pressure for approx. 24h.

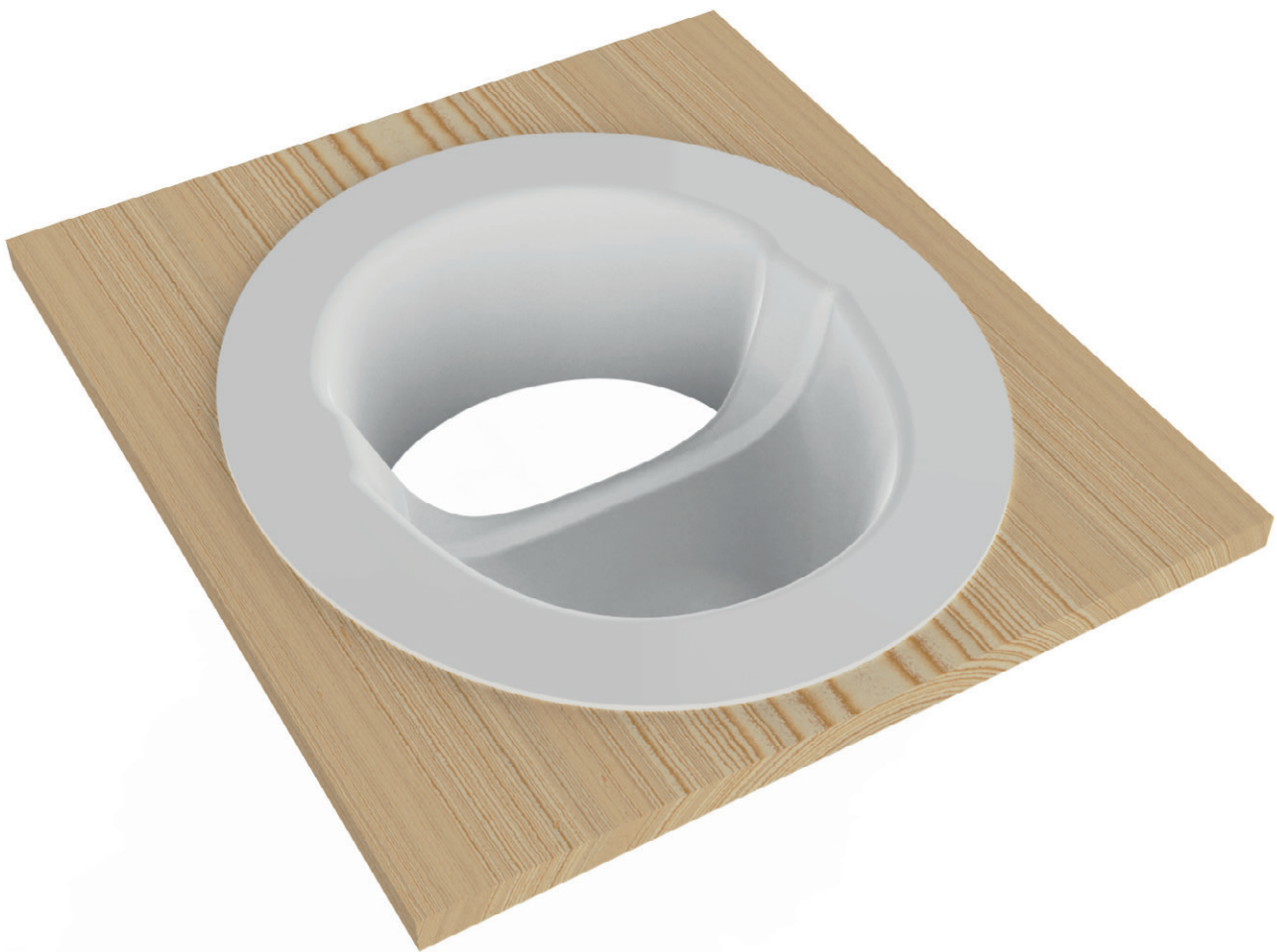



 **BETRIFFT NUR DEN KILDWICK KLASSIK XL**
Concerns only the Kildwick Classic XL!

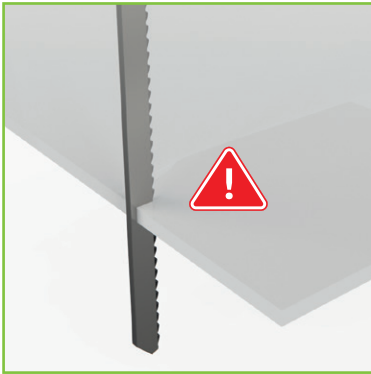

 **KEIN VORSCHUB! GERINGE DREHZAHL!**
No feed! Low speed!

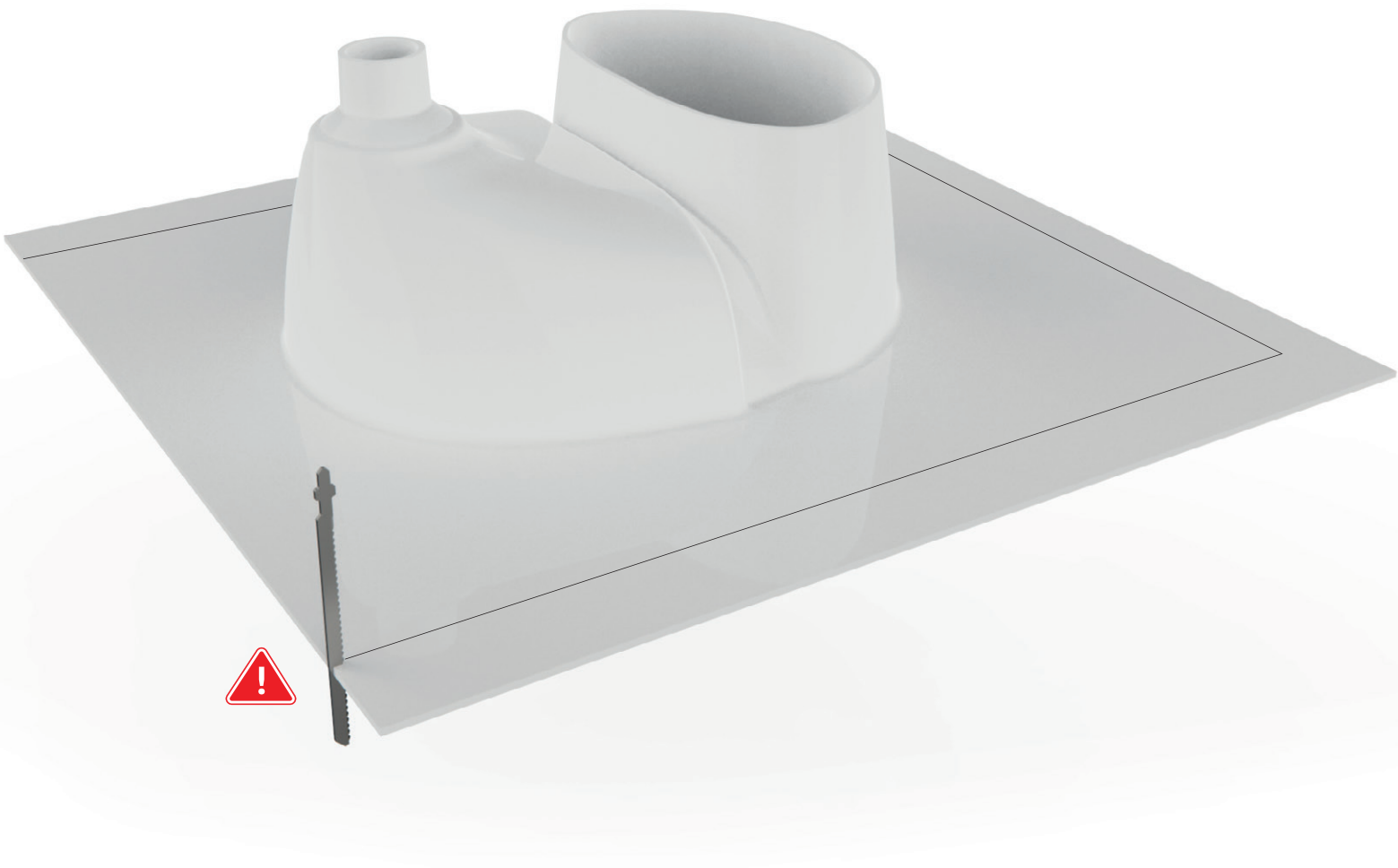

 **BETRIFFT NUR DEN KILDWICK KLASSIK XL**
Concerns only the Kildwick Classic XL!



 **DIREKTER SCHLAUCHANSCHLUSS AM TRENNEINSATZ IST NICHT VORGESEHEN!**
Direct hose connection to the separator is not provided!

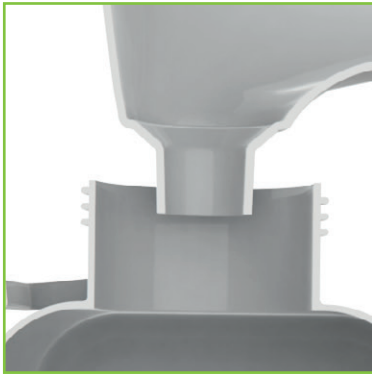

✓ **EINFACHE ABLEITUNG IN EINEN URINTANK.**
Easy drainage into a urine tank.



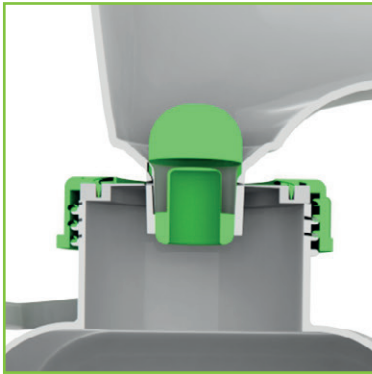

EINFACHE ABLEITUNG IN EINEN URINTANK MIT KILDWICK SPILLGUARD.
Easy drainage into a urine tank with the Kildwick Spillguard.





 **EINFACHE ABLEITUNG MIT DEM KILDWICK SIPHON.**
Easy drainage with the Kildwick Siphon.



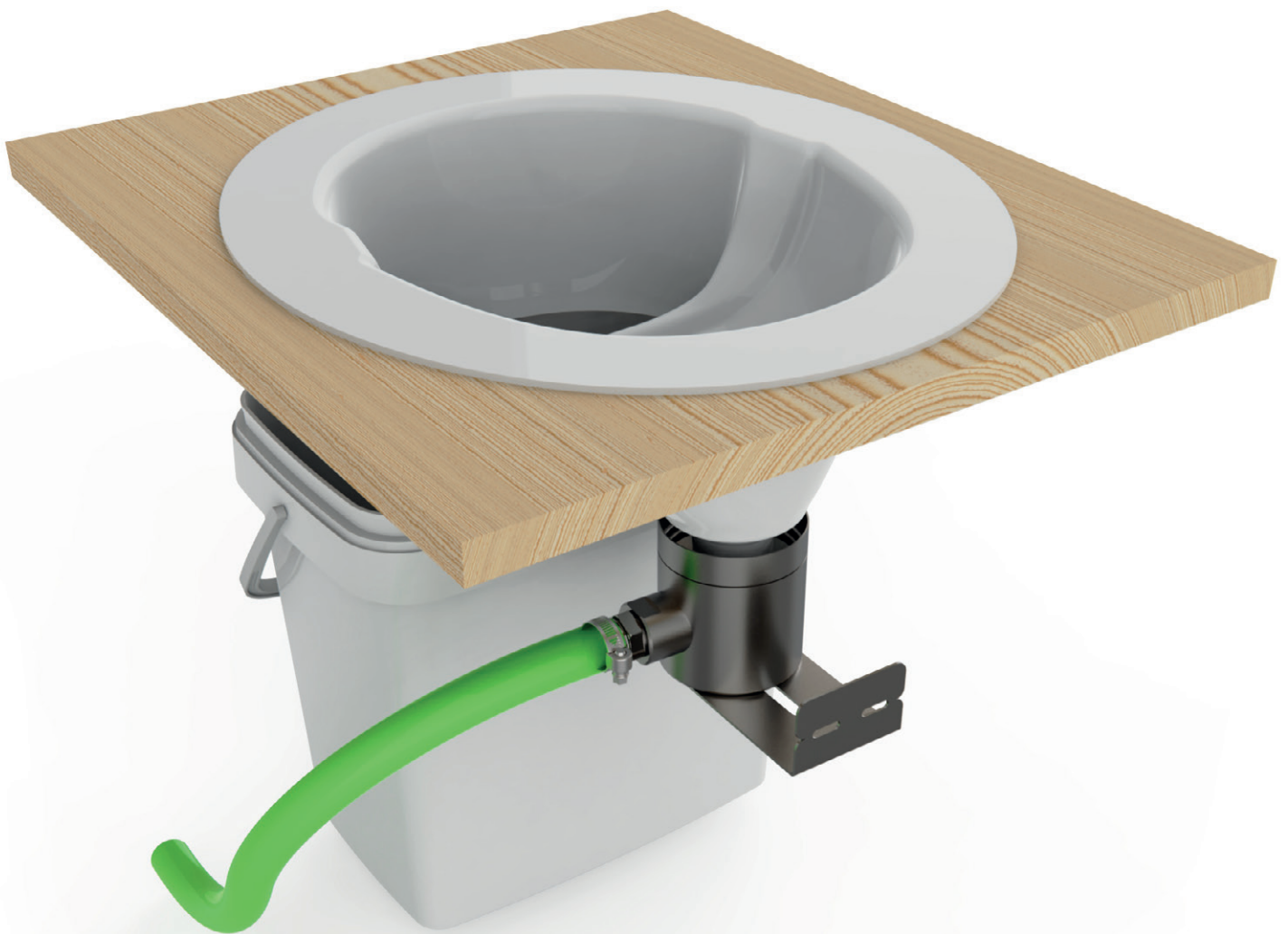

 **SCHLAUCHANSCHLUSS 19MM ZU EXTERNEM TANK.**
Hose connection 3/4 inch to external tank.



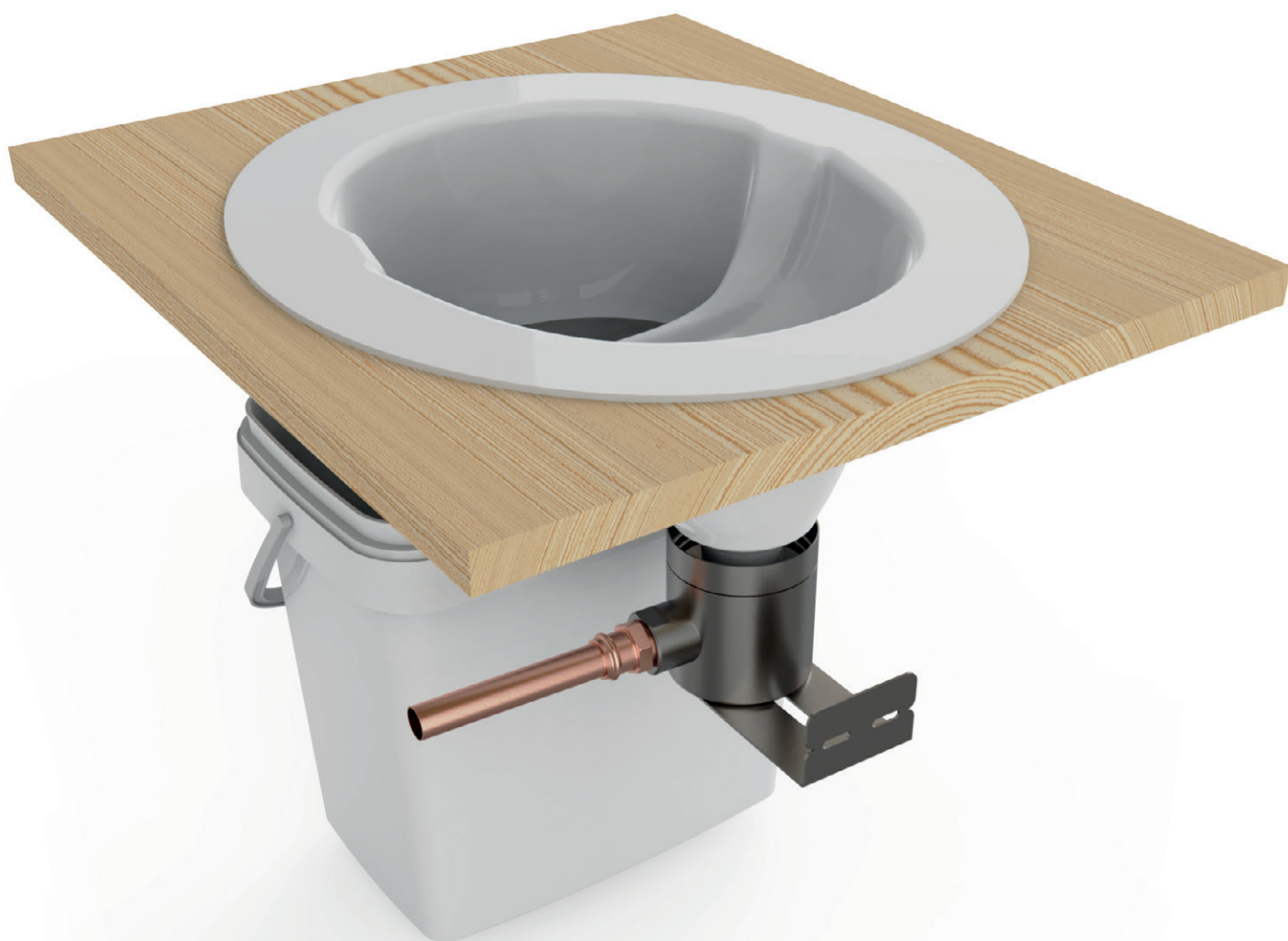

✓ **KUPFERROHR ZU EXTERNEM TANK.**
Copper tube to external tank.





ARTEN DER ABLEITUNG | DERIVATION TYPES

KILDWICK FREELOO



✓ **EDELSTAHLROHR ZU EXTERNEM TANK.**
Stainless steel tube to external tank.



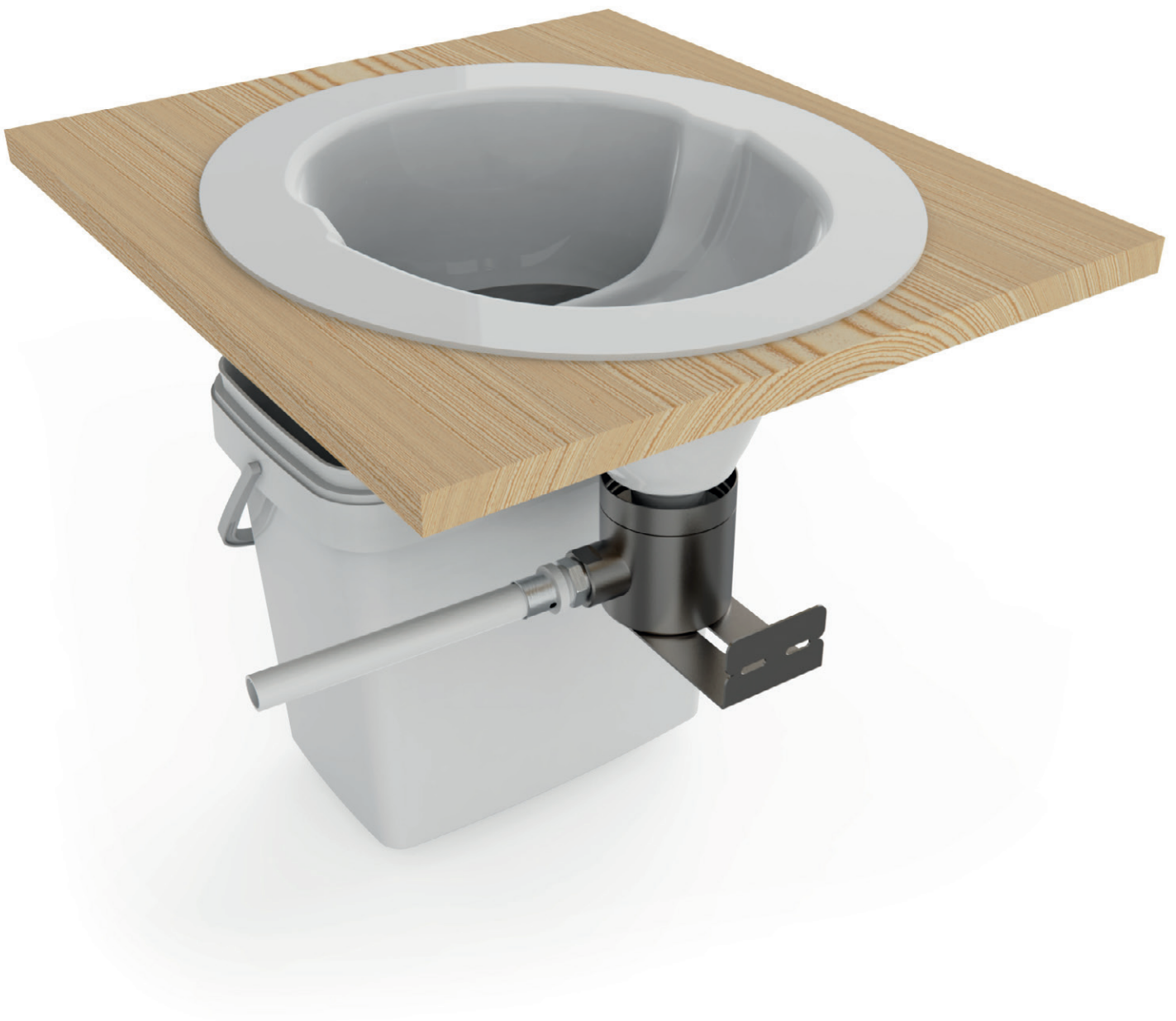

 **ALU-VERBUNDROHR ZU EXTERNEM TANK.**
Aluminium composite tube to external tank.





REINIGUNG / Cleaning

Der Trenneinsatz kann einfach mit Wasser ausgespült werden. Natürlich nur bei leerem Feststoffbehälter ;-)
Wenn sich Beläge absetzen, handelt es sich nicht um Urinstein und kann deshalb mit unserem Kildwick beeta Rote Bete Bad Reiniger oder warmen Wasser abgewischt werden. Alternativ kann auch eine Essiglösung (1:1 mit Wasser) verwendet werden. Ist einmal etwas daneben gegangen, kann das mit Toilettenpapier entfernt werden. Das Toilettenpapier kann ruhig im Feststoffbehälter landen.

Feststoffbehälter:

Nutze den Feststoffbehälter nicht ohne eine Tüte. So verringert sich Dein Reinigungsaufwand immens. Bitte vor der Benutzung eine kompostierbare Tüte in den Behälter einsetzen und bestenfalls schon 1-2 Hände voll Einstreu in die Tüte werfen. Nun kannst Du den Behälter benutzen.

Urintank:

Nach 2-3 Tagen kann sich ein Geruch im Urintank entwickeln, hervorgerufen durch Bakterien, die den Harn zersetzen. Diesem Geruch kannst Du entgegenwirken, wenn Du den Tank regelmäßig entleerst. Alternativ kannst Du unseren „Spillguard-Kit“ nutzen um eventuelle Gerüche im Urintank zu halten. Zum Reinigen kannst Du den Urintank mit Wasser ausspülen.

The separator insert can easily be rinsed with water. Of course only with empty solids container ;-)

Any debris can be wiped off with our beeta - ecological cleaner for sanitary facilities or warm water. Alternatively, a vinegar solution (1: 1 with water) can be used. Any spills around the edges can be removed with toilet paper which can be put in the solids container.

Solid container:

Do not use the solid container without a bag. This reduces your cleaning effort immensely. Please insert a compostable bag into the container before use and throw 1-2 hands full of litter into the bag at best. Now you can use the container. The compostable bags you can also buy in our shop.

Urine tank:

After 2-3 days, a smell may develop in the urine tank, caused by bacteria that decompose the urine. This odor you can counteract if you empty the tank regularly. Alternatively, you can use our "Spillguard-Kit" to keep any odors in the urine tank.

For cleaning, you can rinse the urine tank with water.



ACHTUNG / Attention

- keine scharfen oder spitzen Gegenstände auf der Oberfläche benutzen
- keine Lösungsmittel zum Reinigen verwenden
- kein heißes, sondern nur handwarmes Wasser benutzen
- keine Scheuermilch oder kratzende Schwämme verwenden
- keine schweren Gegenstände hineinfallen lassen (Bruchgefahr)
- Urinbehälter regelmäßig leeren, spätestens sobald der Füllstand im Sichtfenster den oberen Rand erreicht hat
- *do not use sharp or pointed objects on the surface*
- *do not use solvents for cleaning*
- *do not use hot water but only lukewarm water*
- *do not use scouring or scratching sponges*
- *do not let heavy objects fall into it (Breakage)*
- *Empty the urine container regularly, at the latest as soon as the level in the viewing window has reached the upper edge*

**BIST DU HAPPY MIT DEINER TOILETTE?
DANN TEILE DEINE FREUDE UND BEWERTE DAS TTT AUF UNSERER WEBSITE.**

**ARE YOU HAPPY WITH YOUR LOO?
THEN SHARE YOUR EXPERIENCE AND WRITE A REVIEW ON OUR WEBSITE.**